



# DRUM PUMP MOTORS MODEL 16450 SERIES D100 SIZE

## INSTALLATION & SERVICE INFORMATION

### FEATURES

- Rugged construction
- Flow rate of 26 GPM (100 LPM)
- Self-aligning drive coupling
- Designed for use with gloved hands
- Built-in power switch safety guard
- 115V AC 50/60 Hz or 230V AC 50/60 Hz 1Ø and **CE** models
- U.S., British, and European electrical plug models
- Integral circuit breaker with manual reset standard
- Optional low voltage safety shut off with manual reset
- 20 foot oil resistant power cord

### MOTOR SPECIFICATIONS

<b>Motor Type:</b>	115V AC 60 Hz 10 220V AC 50/60 Hz 10
<b>Brushes:</b>	Replaceable
<b>Current:</b>	5.8 Amps, 115V AC, 10,600 RPM, 600 Watts 2.7 Amps, 220V AC, 10,600 RPM, 540 Watts
<b>Power Factor:</b>	.92
<b>Ambient Temperature:</b>	40°-120°F (4°-53°C)
<b>Duty Cycle:</b>	Intermittent
<b>Enclosure:</b>	Weather protected, fan cooled
<b>Weight:</b>	7.5 lbs (3.4 kgs)

### APPLICATIONS

The new and improved 16450 Series motors replace all older style 16420 Series motors and are compatible with all Jabsco D100 size drum pump tubes. Jabsco D100 size pumps quickly and easily transfer and dispense liquids



Model 16450 Series Drum Pump Motors

from drums and tanks. Jabsco drum pump tubes are available in polypropylene, stainless steel, hygienic stainless steel, and Kynar to assure compatibility with most liquid chemicals. Tubesets come in a variety of lengths to accommodate most standard containers. Not for use with flammable liquids or in explosive environments. For more information, please refer to the data sheets listed below.

### D100 PUMP TUBESETS FOR USE WITH 16450 SERIES MOTORS

Series	Tube Material	Data Sheet No.
16400	Polypropylene	43000-0572
16410	Stainless Steel	43000-0573
16520	Kynar	43000-0586
16510	Stainless Steel Hygienic	43000-0585

Model No.	Power	Options	Plug	CE
16450-0115	115 VAC 60 Hz Ø1	CB	US	No
16450-1115	115 VAC 60 Hz Ø1	CB, LV	US	No
16450-2115	115 VAC 60 Hz Ø1	CB, LV, CE	US	Yes
16450-4115	115 VAC 60 Hz Ø1	CB, LV, CE	None	Yes
16450-0220	230 VAC 50/60 Hz Ø1	CB	None	No
16450-3220	230 VAC 50/60 Hz Ø1	CB, LV, CE	EU	Yes
16450-2220	230 VAC 50/60 Hz Ø1	CB, LV, CE	UK	Yes

OPERATION

**SAFETY PRACTICES**

Protective clothing, gloves and safety glasses should be worn when operating the Jabsco drum pump. All

**⚠ WARNING**  **Explosion hazard. Do not pump gasoline or other flammable liquids. To do so can cause an explosion resulting in injury or death.**

**⚠ WARNING**  **Hazardous Voltage. Prior to any disassembly or assembly of the Jabsco Drum Pump Motor, make certain that all electrical power to the motor is disconnected and prevented from accidentally being connected. Failure to do so can cause death or injury.**

**⚠ WARNING**  **Explosion hazard. Do not pump gasoline or other flammable liquids. To do so can cause an explosion resulting in injury or death.**

standard safety practices must be followed. Jabsco 16450 motors are weather protected and should not be submersed or exposed directly to water or other liquids. Electrical shock hazard may result.

**MOTOR-TO-PUMP TUBE ASSEMBLY**

Jabsco 16450 Series motors are compatible with all Jabsco D100 size drum pump tubes. Disconnect power from the drum pump motor prior to assembly, disassembly, or maintenance to avoid injury. Thread the pump tube mounting ring on to the threaded motor flange and hand tighten. The motor drive coupling will automatically align itself to the pump shaft. Care should

be taken if operating motor with pump tube as moving parts are exposed.

**ELECTRICAL CONNECTION**

Set the ON/OFF switch to the OFF position and secure the pump before connecting to a power source. Insure that voltage and frequency available correspond to the data on the motor label. Periodically inspect power cord and plug for cracks and abrasions. Replace if damaged.

Some Jabsco drum pump motors are supplied without plugs. An approved plug with earth ground must be installed by a competent electrician prior to use.

**OPERATION**

To dispense small amounts of fluid at lower flow rates, the power switch can be modulated short of its detent by the operator. Repeated momentary operation of the pump provides lower flow rates which can prevent splash and over-fill. For continuous operation depress the power switch fully into its detent. The pump will run continuously until switched OFF by the operator.

**LOW VOLTAGE SAFETY PROTECTION (LV)**

Jabsco drum pump motors can be factory equipped with a low voltage shut off device (LV). The LV circuit turns the motor off automatically if electrical power is reduced or lost for any reason. The pump will not resume operation when power is restored unless the LV circuit is reset by turning the power switch to OFF and then to ON. The LV safety circuit prevents the pump from turning ON automatically and/or unexpected when power is restored.

**OVERLOAD PROTECTION**

WIRING DIAGRAM

**16450-4115**

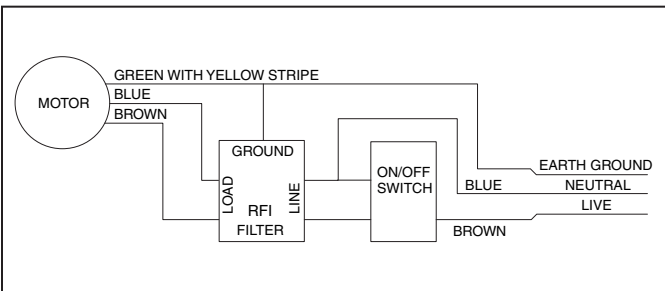

WIRING DIAGRAM

**16450-3220, 2220**

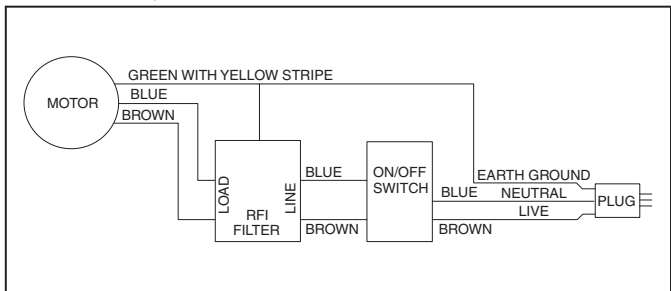

WIRING DIAGRAM

**16450-0220**

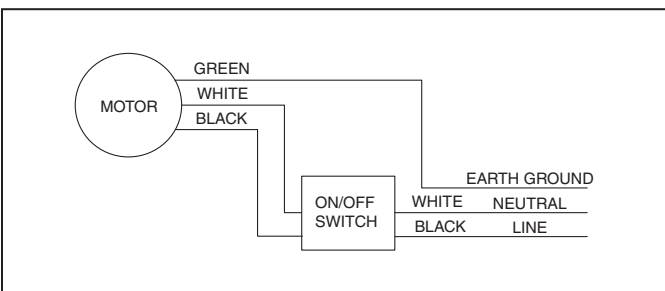

WIRING DIAGRAM

**16450-0115**

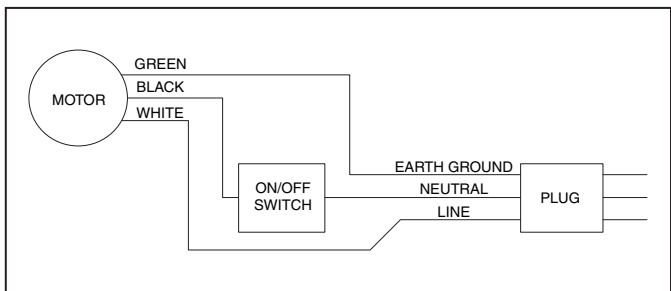

## EXPLODED VIEW

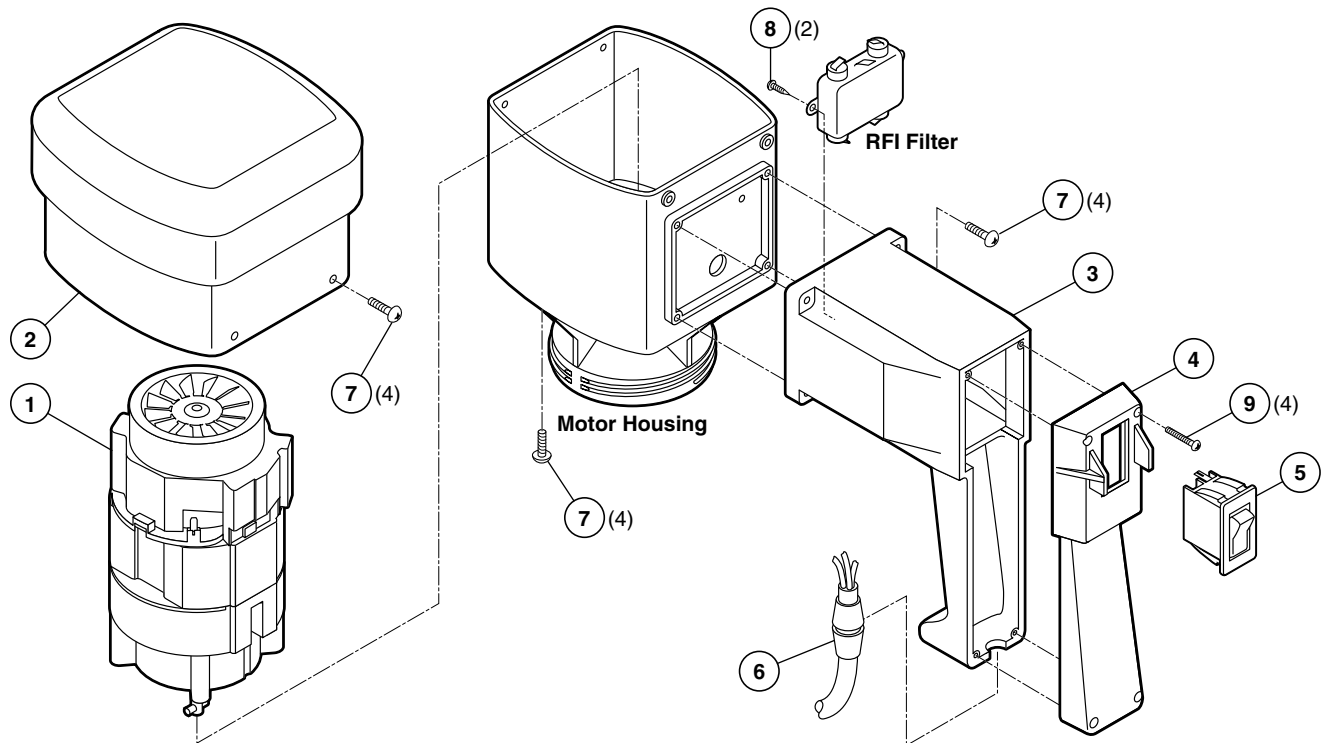

## D100 SIZE MOTOR PARTS LIST

Key	Description	16450-0115	16450-0220	16450-1115	16450-2115	16450-3220	16450-2220	16450-4115
1	Motor	18753-0680	18753-0681	18753-0680	18753-0680	18753-0681	18753-0681	18753-0681
2	Cover Kit	18753-0682	18753-0682	18753-0682	18753-0682	18753-0682	18753-0682	18753-0682
3,4	Handle Kit	18753-0683	18753-0683	18753-0683	18753-0683	18753-0683	18753-0683	18753-0683
5	Switch Kit	18753-0684	18753-0694	18753-0685	18753-0685	18753-0686	18753-0686	18753-0685
6*	Power Cord Kit	18753-0687	18753-0695	18753-0688	18753-0689	18753-0690	18753-0691	18753-0692
7,8,9	Hardware Kit	18753-0693	18753-0693	18753-0693	18753-0693	18753-0693	18753-0693	18753-0693
10**	Motor brush Kit	18753-0658	18753-0659	18753-0658	18753-0658	18753-0659	18753-0659	18753-0658

\* Power cord plug not shown.

\*\* Motor brushes not shown.

Jabsco drum pump motors are protected from prolonged overload conditions by an internal manual reset circuit breaker. If the motor stops due to an overload condition, turn the ON/OFF switch to OFF and allow the motor to cool. Reset the circuit breaker by manually turning the power switch to OFF. Resume normal operation by turning the power switch ON.

### Spare Parts

Use only Jabsco brand service parts. Consult this data sheet for repair kit part numbers. Remove all power prior to service. Clean and neutralized any chemical residue on

the motor prior to service. Detailed repair procedures are provided with each repair kit.

### Electrical Repairs

Electrical repairs should be made by a competent electrician.

## D100 PUMP PERFORMANCE CURVES

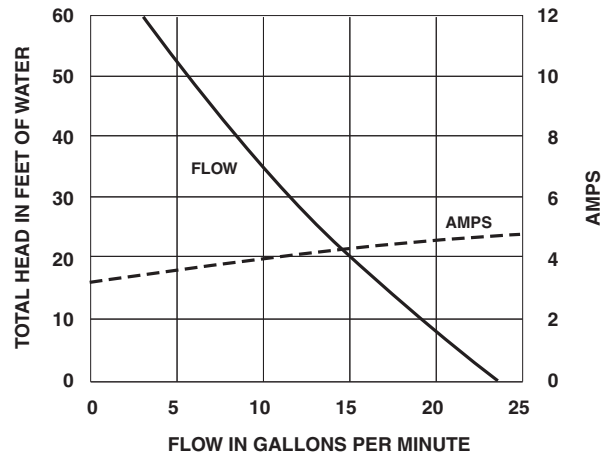
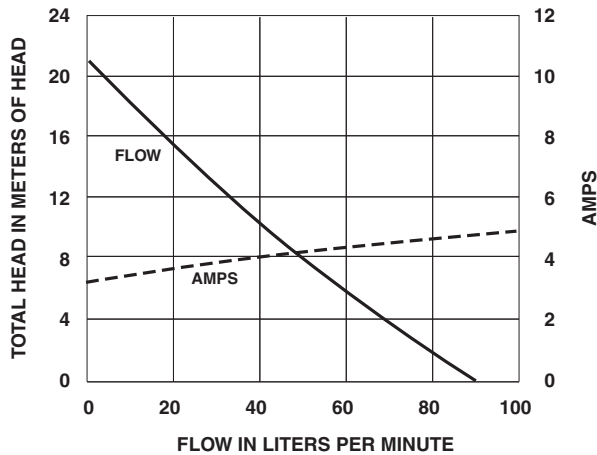

## VISCOSITY REDUCTION CURVE

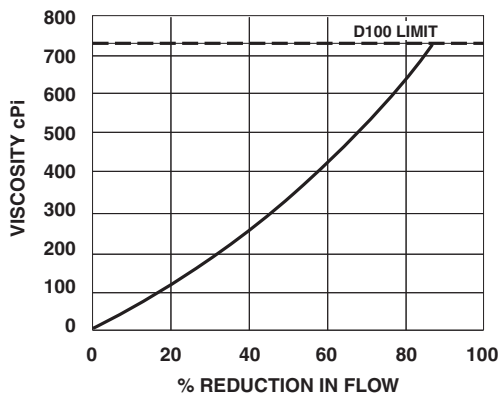

## ACCESSORIES

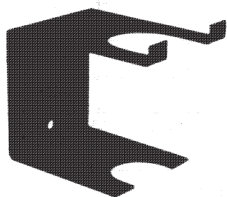

**Storage Bracket**

16470-0000 USA  
23500-0000B Europe



**Adjustable Nozzle**

18753-0070 USA  
23510-0010 Europe

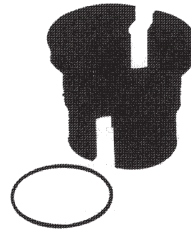

**Drum Adapter**

18753-0080 USA  
23505-0000B Europe

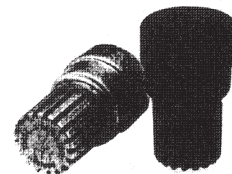

**Strainer**

16490-1000 Polypropylene  
16490-1001 Tefzel

Jabsco



[www.jabsco.com](http://www.jabsco.com)

THE PRODUCTS DESCRIBED HEREIN ARE SUBJECT TO THE JABSCO ONE YEAR LIMITED WARRANTY, WHICH IS AVAILABLE FOR YOUR INSPECTION UPON REQUEST.

**U.S.A.**  
Jabsco  
666 E. Dyer Rd.  
Santa Ana, CA 92705  
Phone: 714.557.4700  
Fax: 714.628.8478

**UNITED KINGDOM**  
Flojet  
Bingley Road, Hoddesdon  
Hertfordshire EN11 0BU  
Tel: +44 (0) 1992 450145  
Fax: +44 (0) 1992 467132

**CANADA**  
Fluid Products Canada  
55 Royal Road  
Guelph, Ontario N1H 1T1  
Tel: 519 821.1900  
Fax: 519 821.2569

**JAPAN**  
NHK Jabsco Company Ltd.  
3-21-10, Shin-Yokohama  
Kohoku-Ku, Yokohama, 222-0033  
Tel: 045.475.8906  
Fax: 045.477.1162

**GERMANY**  
Jabsco GmbH  
Oststrasse 28  
22840 Norderstedt  
Tel: +49-40-53 53 73 -0  
Fax: +49-40-53 53 73 -11

**ITALY**  
Jabsco Marine Italia  
Via Tommaseo, 6  
20059 Vimercate, Milano  
Tel: +39 039 685 2323  
Fax: +39 039 666 307